

REVOLVE

RV-SH-550



USER MANUAL

TABLE OF CONTENT

1. Introduction	1
2. Intended Use	1
3. Symbol	1
4. Features	1
5. Accessories	2
6. Technical Specification	2
7. Safety Instructions	2
8. Standard Parts Listing	5
9. Installation	5
10. User Interface & Display	6
11. Operation	7
12. Troubleshooting	13
13. Maintenance & Cleaning	14
14. Warranty Statement	14
15. Product Disposal	15

1. INTRODUCTION



This manual provides important safety information for this Hot Plate Magnetic Stirrer. It should be kept near the equipment for quick & easy reference. This stirrer is specially designed for precise control of stirring speed and temperature which allows gentle to vigorous mixing with speed ranging from 200 to 2200 RPM with a maximum capacity of 20 Ltr. The multipurpose digital display assists users by displaying various parameters like actual & set temperature, speed, mode of operation, etc.

2. INTENDED USE

The hotplate stirrer is suitable to use for mixing and/or heating the liquids with the maximum capacity of 20 Ltr. It is designed for use in general laboratories, pharmacies, schools and universities.

NOTE: Before using the instrument, please read this user manual carefully. This user manual is intended to assist with the operation and care of the unit only and not its repair. For repair please contact the supplier.

3. SYMBOL

 Warning	 Waste electrical
 Fuse	

4. FEATURES

- Powerful motor for constant speed delivery under varying load
- Stirring capacity up to 20 Ltr
- Nano crystal full ceramic top plate ensures chemical resistivity & constant heat transfer
- Highly resistant and inert body, even to strong chemicals
- Heater temperature setting from 5°C to 550°C (HP550)
- Heater temperature setting from 5°C to 350°C (HP350)
- Variable speed setting from 200 to 2200 RPM in steps of 10 RPM & long timer range from 1-999 mins & infinite mode
- Microprocessor controlled hot plate stirrer with variable speed and time setting, along with last run memory function
- Programmable pulse mode with run pause run feature
- 6 heating modes for rapid, gradual & accurate heating
- Large and clear display for better readability across all parameters, set values readily visible
- Safe temperature circuit cut up to 375°C in HP350 / 575°C in HP550 for greater reliability

4. FEATURES

- Small footprint for saving valuable bench space
- Hot plate indication when temperature reaches above 50° C
- Compatible with PT-1000 temperature probe to accurately measure temperature of medium
- Keypad lock feature

5. ACCESSORIES

- PT 1000 Temperature probe and probe attachment stand
- Magnetic stirring bar
- Power cord
- User manual and warranty card

6. TECHNICAL SPECIFICATIONS

PRODUCT	HP350	HP550
Motor	DC	
Number of stirring position	1	
Max Stirring quantity on Equip (H ₂ O)	20 Ltr	
Speed range	200 to 2200 RPM	
Speed control	10 RPM / Step	
Heating Temp. range	Room Temp. to 350°C	Room Temp. to 550°C
Setting Temp.	5°C to 350°C	5°C to 550°C
Safe Temp	375°C	575°C
Temperature setting resolution	1°C / Step	
Time range	0 to 999 minutes & Infinite	
Heater Control Accuracy (+/-K)	±10 °C	
Recommended Stirring bar length	25 mm	
Set-up plate material	Ceramic	
Set-up plate dimensions	180 x 180 mm	
Dimensions (L x W x H)	313 x 205 x 110 mm	
Protection class	IP 21	
Permissible ambient temp.	5-40°C	
Permissible relative humidity	≤80%	
Weight	4.9 Kg	

6. TECHNICAL SPECIFICATIONS

Altitude	Use upto an altitude of 2000 m above MSL
Pollution Degree	2
Environment	For indoor use only
Input Voltage	220-240V, 50Hz
Motor rating input & Output	5-7 W
Total Power Consumption	1000 W
Safety Fuse Rating	5Amp

7. SAFETY INSTRUCTIONS



Read all safety & usage information provided in this manual carefully before using the device.

1. Place the device on a flat, stable, clean, non-slippery and fire-proof surface.
2. Ensure that only trained staff uses the device. Keep the instructions manual in a place where it can be accessed easily.
3. Beware of the possible effects of magnetic field on pacemakers, data media, etc.
4. Do not touch the hotplate surface when temperature of hotplate is over 50°C, this could result in serious burns or injury. Pay attention to the residual heat after switching off.
5. Properly lift the device with both hands while moving or installing. Also, the device should only be moved from its position once it attains the room temperature.
6. Make sure that power supply cord or temperature sensor cable must not come in contact with the heated mounting plate.
7. Do not place any steel or magnetic material on the top surface except the recommended magnetic stirring bar with beaker or flask in between. Doing this can affect the magnetism of device.
8. Wear your personal protective equipment in accordance with the hazardous category of the media to be processed. Otherwise, there is a risk from:
 - Splashing and evaporation of liquids.
 - Ejection of parts.
 - The release of toxic or combustible gases.
9. The top surface must be clean and kept intact. Wear protective gloves while cleaning the device. Use a soft mild cloth to clean.
10. Do not use damaged beaker, flask, stirring bar or any other component for operation. It may affect the efficiency of the device.

7. SAFETY INSTRUCTIONS

11. Reduce the speed if:
 - If the medium splashes out of the vessel due to high speed.
 - If the appliance is not running smoothly.
 - If the container moves on the base plate.
12. Do not move the device when it's connected to power supply or during its operation.
13. Ensure that the product is used only for specified operation. It should not be used for shaking hazardous or reactive solutions.
14. Give specific attention to the risks associated with:
 - Flammable materials.
 - Flammable media with low steam pressure.
 - Overfilling of medium.
 - Incorrect vessel size.
 - Unstable vessel.
 - Glass breakage.
15. Do not use the device in explosive atmosphere, it is not Ex protected with substance capable of forming an explosive mixture. Appropriate safety measure must be taken.
16. Note that, there is a possibility of contamination or unwanted chemical reaction.
17. The RTD (PT 1000) sensor must always be immersed in the medium by at least 20 mm.
18. The rating of power supply must match with the specified rating.
19. The top surface will be hot after any heating operation. Do not touch the top surface till the hot LED indication glows.
20. Process pathogenic materials only in a closed vessel under a suitable extractor hood. Do not operate the appliance in explosive atmospheres, with the hazardous substance or under water.
21. Only that liquid should be used for mixing which does not react dangerously to the extra energy produced through processing. This also applies to any extra energy produced in other ways. For example: Through light irradiation, through surrounding temperature etc.
22. Abrasion of the dispersion equipment or the rotating accessories can get into the medium you are working on.
23. The chemical reaction of PTFE can occur when in contact with molten or dissolved alkaline earth metals, as well as with fine partied powders of metals of the 2 and 3 group of the periodical system at temperatures above 300-400 °C. Only elementary fluorine, chlorine trifluoride and alkaline metals do attack PTFE, halogen hydrocarbons have a reversible swelling effect. Only glass-coated

7. SAFETY INSTRUCTIONS

magnetic rods should be used in combination with solute alkali metals or alkaline earth metals or at the temperature above 250°C.

24. To protect do not cover the device, even partially, with elements such as metallic plates or sheets otherwise it may overheat. Ensure that mounting plate remains clean.
25. The socket must be earthed (protective ground contact).
26. Do not use the device if the ceramic set-up surface is damaged.
e.g. scratches, splinters or corrosion. A damaged set-up surface could break if used.
27. Safety Fuse is provided of 5Amp configuration which can be replaced by the operator. The same will protect the machine circuit during an electrical fault or overload.

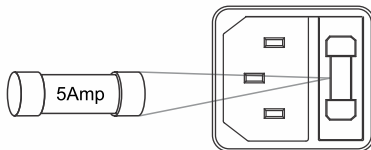

8. STANDARD PARTS

Front Side

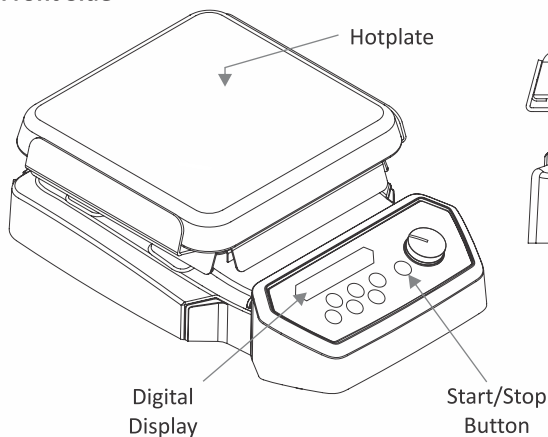

Rear Side

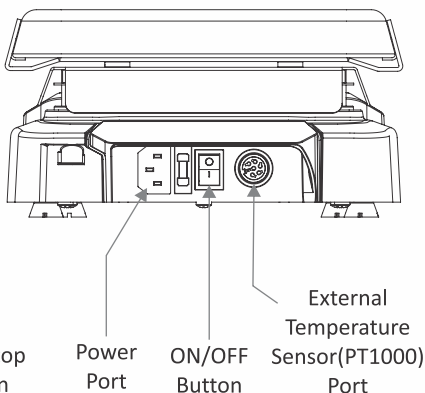

9. INSTALLATION

The hot plate stirrer is provided in a box. Open the box, then remove the packaging and gently place the device on the firm & leveled surface. Take care while unpacking & removing all accessories. The user manual should be kept with the device for easy access. Please keep all packaging in safe storage for at least two years for warranty purpose.

9.1 LOCATION & MOUNTING

Place the stirrer on a flat and leveled surface & ensure that all the four legs of this stirrer stand on the surface firmly. Avoid installing on a slippery surface or surface

9. INSTALLATION

prone to vibration.

1. Ideal ambient temperature is $25^{\circ}\text{C} \pm 1^{\circ}\text{C}$, avoid placing the unit in direct sunlight.
2. Keep clearance of at least 20 cm from all side to increase the cooling efficiency.
3. Keep the unit away from heated solution to avoid sample temperature issues.
4. Do not place the equipment at a place where it becomes difficult to operate it.

9.2 ASSEMBLING SUPPORT ROD STAND

1. Screw in the support rod manually until it cannot be tightened any further.
2. Assemble the accessories mentioned in section 4 using a clamp.

9.3 CONNECTING POWER CORD

1. Connect one end of the power cord to the rear side of the stirrer and another end to the power supply as shown in the figure below.
2. Push the power cord firmly for proper connection and turn ON the main switch.
3. Make sure that input power source is according to stirrer requirement.

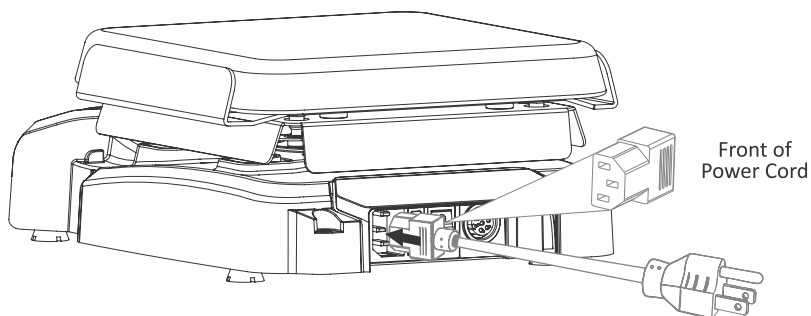

10. USER INTERFACE & DISPLAY

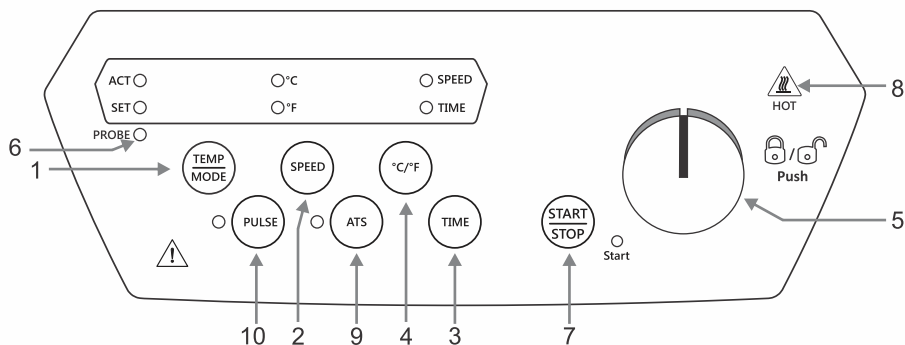

10. USER INTERFACE & DISPLAY

Display

ACTUAL	SET	°C °F	RPM	Mins	PROBE ●
200	320		2200	999	
Display shows Set and Actual Temperature value		LEDs indicates in which unit temperature is displayed	Display shows current speed & time values		LEDs indicates temp. displayed is of PROBE

Item	Name	Function
1	TEMP	Press “TEMP” to select Temperature value. Then rotate knob to set Temp value in °C.
2	SPEED	Press “SPEED” to select Speed value. Then rotate knob to set Speed value in RPM.
3	TIME	Press “TIME” to select time value. Then rotate knob to set Time value in minutes.
4	TEMP. Selection	Press “°C/°F” to change the unit in which Temp. is displayed.
5	KNOB	Rotate right side to increase values.
		Rotate left side to decrease values.
		Press to Lock/Unlock the keypad.
6	PROBE	To display temperature of probe at actual temp. display.
7	START/STOP	Press “START/STOP” to start or stop any operation.
8	HOT LED	Glows when top plate of the stirrer is HOT equal or above 50°C.
9	ATS	“Auto Start Mode”. Machine resumes from the left parameter.
10	PULSE	Pulse mode for Run Pause Run operation.

11. OPERATION

11.1 SWITCHING ON THE DEVICE

Plug the power cord into its socket on the rear panel, now connect the power cord to. AC power output. Now switch ON the mains and switch ON the stirrer from the rear/back side, as shown in the figure. The power LED on its front panel will glow.

11. OPERATION

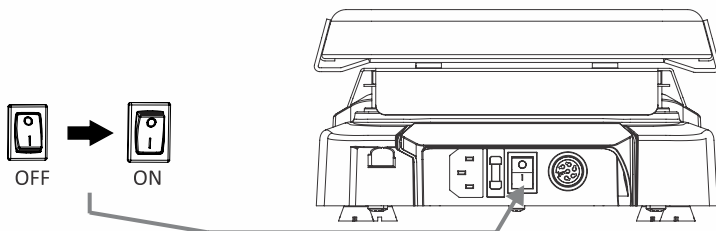

IMPORTANT NOTE: Values of any parameter will get set saved only after the respective display blinks for multiple times.

11.2 SAFE TEMPERATURE

Safe temp range 50 °C to 375 °C (HP350) / 50 °C to 575 °C (HP550). Upon turning the machine on, the stirrer screen will display with SAFE temp setting. Set the safe temperature by rotation knob clockwise for increment & counter clockwise for decrement. Only “Knob” & “°C/°F” key will work, other keys will remain deactivate while setting the safe temperature. Safe Temp can be set in both - Celsius or Fahrenheit. After adjusting temp, value will be save after blinks and then it will take to home screen.

NOTE: This is a safety feature where if the temperature of heater exceeds the value saved in safe mode then operation (heating & stirring) will stop. The safe temperature limit must always be set to at least 25 °C lower than the fire point of the media used.

11.3 CONTROL PANEL OPERATION

SET and ACTUAL LEDs will FLASH as per status of the command. By rotating knob values can be increased and decreased for each parameter. “START/STOP” button for operation start and stop. “SPEED”, “TIME” and “TEMP” buttons to select it respective values.

11.4 START/STOP FUNCTION

Press “START/STOP” key to Start operation (once all the parameters are set). This will be indicated by start/stop LED. If the LED is ON, means the operation is running or if the machine is turned off the LED will stop glowing. Press this button again to “STOP” operation. If temp is “Abt” and RPM 0 then start button doesn't work.

11.5 TEMPERATURE BUTTON

To set the temperature, press “TEMP” key and change value by rotary knob from 5°C to 350°C (HP350) / 5°C to 550°C (HP550). After setting desired value, value will save automatically after blinks. After value saved actual LED will automatically flash on (once the “START/STOP” key is pressed). Temperature value can be changed during

11. OPERATION

continuous operation. If the operator want to check set value then, it can be seen by pressing “TEMP” button again during operation.

11.6 °C/°F KEYS

The Temperature can be set in Celsius or Fahrenheit, on home screen. By pressing “°C/°F” button, the °C or °F will be displayed alternatively. Whichever will be selected, the Actual Value and set Value of Temp will change automatically. While changing Temp Unit, the respective value will be rounded off for the converted unit & will display. Each unit selected will be indicted by respective LED.

11.7 HEATING MODE

6 different heating modes can be set when on home screen.

By long press “TEMP/MODE” button, setting display will blink and shown as H03 as default, by rotary Knob one can switch between - H00, H01,H02,H03,H04 and H05. All other functions/keys will remain inactive while setting this parameter. Once the heating mode is selected the parameter will set automatically.

NOTE: Temperature accuracy is claimed as per water, if liquid medium changed the accuracy may change.

1) H00: Slow Heating for Low volume Liquid & high Accuracy (up to 300ml)

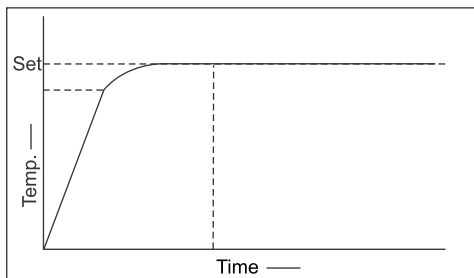

This mode is basically for Lower volume i.e. Up to 300ml. The accuracy for this mode is very High, so it is not suggested for higher volumes. After setting up the required parameters, if the user starts the operation the temperature rises Slowly & stabilizes to the set value.

NOTE: This mode is design for zero over shoot of heating liquid, it will take time if the liquid volume increase or liquid type changes.

2) H01 : Slow heating with High Accuracy (300ml to 800ml)

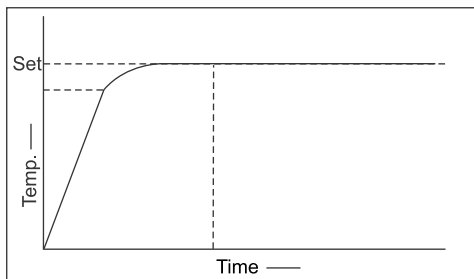

This mode is very useful for the solutions which are very sensitive to a change of temperature, it is basically for volume above 300ml to 800ml. After setting all parameters when user presses “START”, the initial temperature of device will rise quickly to a point below the set value of temp.,

11. OPERATION

then the temperature will rise slowly with high accuracy to set value & once it attains the set value then the temperature will remain constant for the remaining time with the high accuracy of $\pm 1^{\circ}\text{C}$ in water.

NOTE: *If the Liquid media change than accuracy may differ from specified.*

3) H02 : Fast heating with High Accuracy (800ml to 2L)

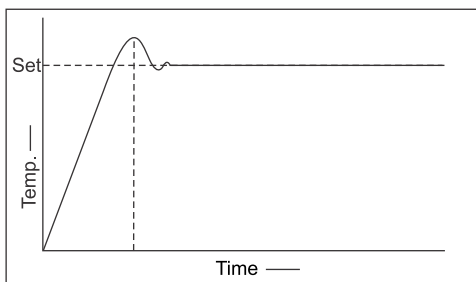

This mode is useful when the user wants to heat the solution quickly, it is basically for volume above 800ml to 2L volume. In this mode after setting all parameters when the user presses "START", temp. of unit rises quickly to the set value point & then it stabilizes to set value. Initially, temperature may vary up to $\pm 15^{\circ}\text{C}$. After stabilizing,

temperature of the plate will remain constant with high accuracy of $\pm 1^{\circ}\text{C}$.

4) H03 : Rapid Heating with Overshoot (1L to 2L)

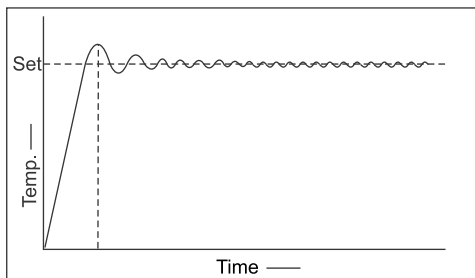

This mode of heating is useful when user wants to heat the solution rapidly without the concern of accuracy of temperature, it is basically for volume above 1L to 2L . In this mode after setting all parameters when user presses "START", initial temperature of device will rise very fast to the set value of temperature and once it reaches the

set value device will slowly stabilize the temperature to the set value. In this mode, heating will be much more rapid then previous two modes and possible overheating could be up to $\pm 20^{\circ}\text{C}$.

5) H04: Rapid Heating for High volume Liquid (2L to 5L)

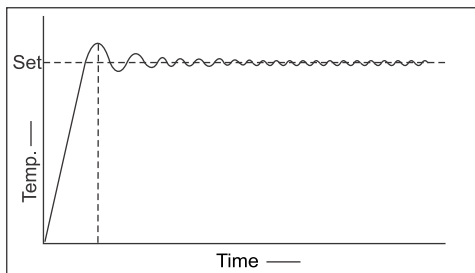

This mode is similar to H03 mode, but it is basically for high volume i.e. 2L to 5L. After setting up the parameters if the user starts the operation, the temperature will rise with high rate and will gradually stabilize to the set value. In this mode the accuracy is not that accurate as attained in the previous

11. OPERATION

modes.

6) H05: Rapid Heating for High volume Liquid (6L to 20L)

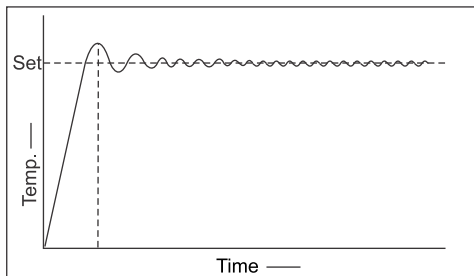

This mode is basically for higher volume i.e. 5L to 20L. The accuracy for this mode is very low, so it is not suggested for lower volumes. After setting up the required parameters, if the user starts the operation the temperature rises rapidly & stabilizes to the set value.

11.8 SPEED FUNCTION

To set speed, press “SPEED” button on home screen indicated by speed LED flashing on. Speed can be set by rotating the knob in proper direction for increment or decrement ranging from 0-2200 RPM in the range of 10 RPM of increment or decrement to the parameter. Default RPM is always be as last set RPM. Heater can work even at 0 RPM. After adjusting the speed, will save automatically once the screen stops blinking.

11.9 TIME FUNCTION

On Initiation of the machine the value on window will display " ∞ ". The timer can be set from 1 to 999 minutes & infinite (" ∞ ") minutes. By pressing “TEMP” key once, timer can be set which will be indicated by LED.

By rotary “knob” the time LED will be flash on. It will show the Time command activation and we can change time parameters in this situation.

To set time value, rotary Knob for increment and decrement of Value from 1 to 999 Minutes. After set desire value in window, the value will blink then stop, it means the value is save. If operator want to see Set value then he can be see by pressing time button. Time unit will be in minute. In running condition if time recharge, timer will reset & count from the beginning.

11.10 HOT LED

Hot surface indication will turn on when the plate surface reaches 50°C & remain on until the temperature falls down below 50°C.

The Hot surface indication remains active even the machine is turned off but the main must remain ON this let one avoid accidental usage of the machine when the surface is still hot.

11. OPERATION

- HOT PLATE LED will ON even on/off switch off when temperature comes down below 50 °C.
- Stirring will continue start while Hot Plate LED not off.

11.11 OPERATING MODE

All parameter settings are saved automatically when the device suddenly switched off. Once end user switch on the device, the “START/STOP” key starts the device again with the set parameters.

11.12 ABT TEMPERATURE

By press “TEMP” button, the temp Set value blink and by Rotating “knob”, you will see "Abt" on screen. By set Abt on screen you can run stirrer without heating. Temp setting range ambient to 350°C/550°C, You can not set temp below Abt temp.

11.13 LOCK /UNLOCK KEYPAD FUNCTION

By Long Pressing “knob”, One can Lock buttons after Starting the operation & the display Shows “LOC” blinking. Only “START/STOP” button can work during this Function. By Long Press “knob” again, You can unlock display buttons & the display Shows “Unlo” blinking. After pressing “STOP” button in “LOC” condition during operation, “START/STOP” button will also belocked. In that condition, One have to “Unlock” buttons to Start Operation again.

In ATS Mode, the Lock mode will be unlocked by only two ways. Either by pressing the “knob” or if the unit is restarted after the ATS operation is over. While the ATS operation is running the Lockmode will be remain ON even there is a power cutoff & the unit restarts. Otherwise buttons stay “Unlocked” in all condition.

11.14 ATS MODE

By pressing “ATS” key, ATS LED will show & ATS mode will be activated. To deactivate ATS mode again press “ATS” key and you can press “STOP” button to exit from ATS Mode. After complete timer countdown, at the end of operation you will automatically exit from ATS mode. After power cutoff time will save only in minute not in seconds.

Example: If you have set the timer for 10 minutes and after 7:30 minutes there is power cutoff then it will save 7 minutes only, after power resuming it will start from 7 minutes.

11.15 PULSE MODE

You can set the PULSE mode, when you will on home screen. By pressing “PULSE” button, the White LED will be ON and pulse mode will be activated, by pressing “PULSE” button again, you can deactivate PULSE mode. You can set Pulse time by

11. OPERATION

long pressing “PULSE” button, You will see S 60 on speed display when you are initiating pulse mode first time.

Pulse Time can be set in range of 30 sec to 99 sec by rotating the knob. Default time for pulse mode will be same as last set pulse time. By default, stirring direction is clockwise. Even In a pulse mode there will be no change in stirring direction. During pulse mode timer function will work parallelly. Pulse mode can be set “ON” or “OFF” while stirrer is in running condition. Pulse mode should run at any SET RPM which is in range of 200-2200 RPM. Time counting of pulse time will counting from beginning.

11.16 PROBE SELECTION

Probe LED will flash only when PT1000 prob is connected to the stirrer. Without probe stirrer will automatically work in plate mode. When probe is connected make sure stirrer should not be in running condition. once prob is connected respective LED will glow.

User will not be able to change plate/probe mode using any key. By removing probe, again device will be on plate mode. End user should remove the probe after complete power off.

12. TROUBLESHOOTING

Any type of malfunction during operation can be identified by error an message on display. Proceed as follows in such cases.

1. Problem: Error 4

Root Cause: Over Temperature Error

- Solution:
- 1) Actual temperature is more then safe temperature
 - 2) Will occur when thermocouple connection issue
 - 3) Temperature controlling fail
 - 4) Inappropriate safe temperature selection

NOTE: After Error 4 safety relay will on for heater cutoff.

2. Problem: Error 5

Root Cause: Temperature Probe Error

- Solution:
- 1) Will occur when probe connection issue
 - 2) Loose connection with device

3. Problem: Error 6

Root Cause: Heater Error

- Solution:
- 1) Will occur when heater fail
 - 2) No increment in temperature even after 6 min after device ON

NOTE: After any Error detection, need to reset unit.

12. TROUBLESHOOTING

4. Problem: Error 8

Root Cause: Probe (PT1000) not in Medium

- Solution:
- 1) Will occur when probe is outside from medium placed on hot plate.
 - 2) To override it, long press button “TEMP”, when error comes.

13. MAINTENANCE & CLEANING

1. Before cleaning the device, allow the instrument to attain room temperature remove the power cord from the mains.
2. To clean the housing of the device from dyes, building materials or cosmetic materials use isopropyl alcohol as a cleaning agent.
3. To clean the housing of the device from food materials or fuels, use water. containing detergent as cleaning agent.
4. Wear proper protective gloves while cleaning the instrument.
5. Be careful that no liquid enters the device during cleaning.
6. Kindly contact suppliers before using any other methods for cleaning.

14. WARRANTY STATEMENT

This product is warranted to be free from defects in material and workmanship for a period of two (2) years from the date of purchase. Your product will be duly repaired upon prompt notification in compliance with the following conditions :

This warranty is valid only if the product is used for its intended purpose and within the guidelines specified in this instruction manual. This warranty does not cover damage caused by accident, neglect, misuse, improper service, natural forces or other causes not arising from defects in original material or workmanship. This warranty does not cover any incidental or consequential damages, commercial loss or any other damages from the use of this product.

The warranty is invalidated by any non-factory modification, which will immediately terminate all liabilities on us for the products or damages caused by its use. The buyer and its customer shall be responsible for the product or use of products as well as any supervision required for safety. If requested the products must be returned to the distributor in well packed and insured manner and all shipping charges must be paid.

Some states do not allow limitation on the length of implied warranties or the exclusion or limitation of incidental or consequential damages. This warranty gives you specific legal rights. This warranty is given expressly in lieu of all other warranties, expressed or implied.

The purchaser agrees that there is no warranty of merchantability or of fitness for

14. WARRANTY STATEMENT

any intended purpose and that there are no other remedies or warranties, expressed or implied, which extend beyond the description on the face of the agreement. This warranty is only applicable to the original purchaser.

Products received without proper authorization will not be entertained. All items returned for service should be sent postage prepaid in the original packaging or other suitable carton, padded to avoid damage. We will not be responsible for damage incurred by improper packaging.

All items returned for service should be set postage prepaid in the original packaging or other suitable carton, added to avoid damage.

This warranty is valid only if the warranty is registered with the supplier within 30 days from the date of purchase.

For your reference, make a note of serial number, date of purchase and supplier here.	
Serial No.:	Purchase Date:
Supplier:	

15. PRODUCT DISPOSAL

In case the product is to be disposed of, the relevant legal regulations are to be observed.

Information on the disposal of electrical and electronic devices in the European Community.

The disposal of electrical devices is regulated within the European Community by national regulations based on EU Directive 2012/19/EU on waste electrical and electronic equipment (WEEE). According to these regulations, any devices supplied after 13.06.05 in the business to the business sphere, to which this product is assigned, may no longer be disposed of in municipal or domestic waste. They are marked with the following symbol to indicate this.

As disposal regulations within the EU may vary from country to country, please contact your supplier if necessary.



REVOLVE

**REVOLVE SCIENTIFIC LLC,
United Arab Emirates.
www.revolvescientific.com
info@revolvescientific.com**